

RETAIL FOLDER

Fermob   
outdoor lounge

Products and dimensions not contractually binding. Fermob reserves the right to modify the technical characteristics of its products.



SYMBOLS

Stacking



Folding



Collapsible



Multifunctional



Extending



U.V resistant.



High Protection



Steel : Index 13

Very High Protection



Steel : Index 22  
Aluminium : Index 13



## FERMOB: NO. 1 FOR COLOURFUL, METAL OUTDOOR FURNITURE

Fermob designs and manufactures metal outdoor furniture that is accessible and full of *joie de vivre* - perfect for anyone wishing to create a stylish, relaxing and friendly garden. Fermob furniture stands out from the crowd thanks to its original designs and extensive range of colours.



Photo : Stéphane Rambaud



Photo : Caroline Briel



Photo : Caroline Briel



Photo : Jean-Marc Palasse



# FERMOB COLOURS

## THE METAL CHART (24 Colours)

Colour	Code	Finish (SL : flay satin MT : mat textured)
Black	08	SL
Storm grey	26	MT
Anodic grey	68	SL
White	01	SL
Linen <b>NEW</b>	19	MT
Nutmeg	14	MT
Russet	09	MT
Paprika <b>NEW</b>	33	MT
Carrot	27	SL
Poppy	67	SL
Peony	15	MT
Fuchsia	25	MT
Garnet	24	MT
Aubergine	28	MT
Cobalt	17	SL
Turquoise	16	SL
Fjord blue <b>NEW</b>	18	MT
Cedar green	02	MT
Savanna	12	MT
Willow green	65	MT
Verbena green	29	SL
Aniseed green	05	SL
Apple green	30	MT
Lemon	31	SL

# FERMOB COLOURS

## THE OTF CHART (Outdoor Technical Fabric)

OTF simple weave (12 Colours)					
Colour	code	Alizé	Costa	Dune	Plein air
Anodic grey	68			●	●
Aubergine	28			●	●
Black	08			●	●
Carrot	27		●	●	●
Cedar green	02			●	●
Fuchsia	25	●	●	●	●
Garnet	24			●	●
Poppy	67			●	●
Savanna	12	●	●	●	●
Storm grey	26			●	●
White	01			●	●
Willow green	65			●	●

OTF simple weave Metallic (3 Colours)				
Colour	Alizé	Costa	Dune	Plein air
Grey	●	●		
Metallic black	●	●		
Pearl white	●	●		

OTF double weave (7 Colours)					
Colour		Alizé	Costa	Dune	Plein air
Aniseed green	N			●	●
Cobalt blue	N	●	●	●	●
Nutmeg		●	●	●	●
Russet		●	●	●	●
Sand				●	●
Turquoise blue	N			●	●
Verbena green	N			●	●

OTF Toiles du Soleil (3 Colours)	
Colour	Dune
Collioure	●
St Cyprien	●
Ste Colombe	●

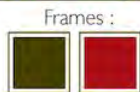

# FERMOB: MATERIALS AND TREATMENT FOR OUTSIDE

For its furniture, Fermob chooses to use metal – the "ideas material", as Gustave Eiffel put it, won over by its incredible versatility. The metals we use are top-grade steel and aluminium. Fermob furniture can be either exclusively metal or a combination of metal and OTF (Outdoor Technical Fabric, a type of PVC-coated polyester).



Fermob furniture undergoes several stages of rust-proofing followed by two paint stages. These treatments are applied at one of the best-performing plants in Europe as part of a process exclusive to Fermob. Two treatments are proposed: the first is the 13-step High Protection Index 13 treatment. This produces excellent results for aluminium, but the results for steel can be further improved with the Very High Protection Index 22 treatment – a 22-stage process, involving the use of 18 treatment baths, which provides optimum protection for steel furniture that is constantly exposed to very wet, humid or salty conditions.

The paint used is a DuPont® 100% polyester, anti-UV powder paint, which is applied electrostatically to the furniture for optimal coverage, and then baked at very high temperature – the same process used in the motor industry.

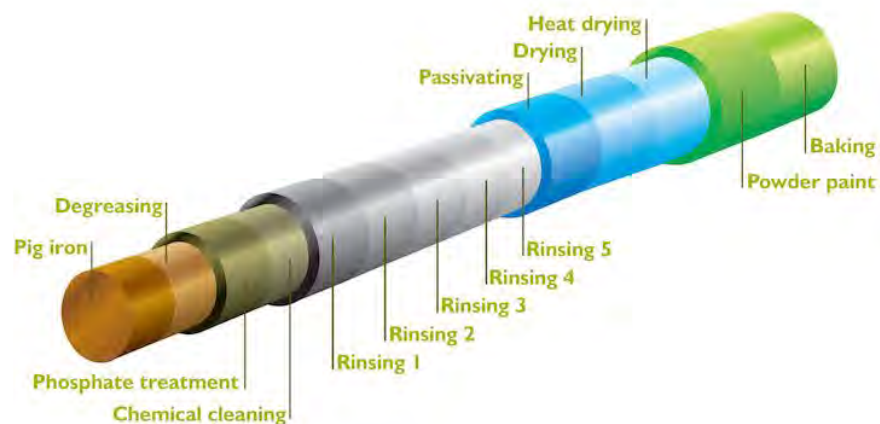

## FERMOB GUARANTEE

All Fermob furniture protected with the Very High Protection Treatment is guaranteed for 3 years against corrosion and other forms of visible deterioration. The Very High Protection Treatment is applied as standard to all of our high-end products. It can, however, be applied to any product in the range upon specific request and subject to conditions.

All Fermob furniture protected with the High Protection Treatment is guaranteed for 1 year against corrosion and other forms of visible deterioration.



### The Fermob guarantee does not cover the following:

- Any damage arising from insufficient care, or from non-compliance with the supplied instructions and advice for receiving, assembling, using, maintaining and storing Fermob furniture.
- General wear and tear or natural fading of the materials used.
- Rust originating from scratches or abrasions that result from general wear and tear, and which can not be removed via standard cleaning and maintenance processes.
- The corrosion of stainless steel parts due to use in a confined, chlorinated environment.
- Any changes in the visual appearance of wood that are directly linked to ageing.  
As wood is a living material, the appearance of its surface evolves naturally over time.

The guarantee will be honoured only upon presentation of the invoice for the purchase of the product concerned.

**More information on the Fermob guarantee and furniture maintenance recommendations can be found at [www.fermob.com](http://www.fermob.com)**



# FURNITURE THAT MAKES ITS MARK ON PEOPLE'S MINDS, NOT ON NATURE

Fermob furniture is designed for natural environments and is made using materials and processes that respect the environment.

## **Metal: an environmentally friendly choice**

98% of all iron and aluminium is now recycled worldwide. This means that Fermob can guarantee that its furniture is not only recyclable, but – more importantly – actually recycled!

## **Ecological paint protects both the environment and your health**

The powder paints used by Fermob contain no solvents. They are 100% recycled and recyclable. They are applied in a zero-waste facility.

## **Recycled fabrics**

To procure its Outdoor Technical Fabrics (OTFs), Fermob selects only the most rigorous suppliers in terms of sustainable development. Ferrari, the main OTF supplier, has committed itself to a unique, patented recycling process, Taxyloop® which guarantees that 100% of the fabric constituents are recycled.

This approach means that:

- OTF offcuts are salvaged and recycled
- Fabrics are recycled when they reach the end of their lifespan

## **Recycled and recyclable packaging**

Fermob has been participating in the Eco-Emballages ("Eco-Packaging") scheme for many years now.

## **Reducing impact on the environment as continuous improvement**

Optimising energy consumption remains one of Fermob's key concerns, as regularly demonstrated through concrete action such as lowering paint-oven temperature by 10°C or the forthcoming implementation of a stoving process that consumes 30% less energy.

## **Eco-designed furniture**

The design and aesthetic qualities of Fermob creations, together with their lightness and resistance, are also solutions to key environmental challenges: saving materials and limiting waste.

### **Intentions backed up with actions**

Fermob was one of the first companies in the furniture sector to introduce a collective waste sorting system, which has now been in place for 8 years.

Fermob is currently in the process of **ISO 14001\*** certification. The certification of the 2nd stage was obtained in October 2009 (this certification process comprises a total of 3 stages).

\*The ISO 14001 standard concerns the implementation of adaptable environmental management systems.



RANGE  
**1900**

Registered trademark



Stacking chair  
Perforated seat - 2201



Stacking armchair  
Perforated seat - 2202



Hanging armchair  
Perforated seat - 2203



Bench  
Perforated seat - 2204



Ø 67 round table - 2232  
2 persons



Ø 96 round table - 2230  
4/5 persons - with parasol hole



Ø 117 round table - 2231  
6/8 persons - with parasol hole



# RANGE 1900

Registered trademark



## TECHNICAL CHARACTERISTICS

Steel rod base.

Hand forged scrolls and rings.

Perforated steel sheet seat.

Perforated steel sheet table top.

Very High Protection Treatment for outdoor use.

100 % polyester baked anti-UV powder coating.

Stackable : Chair x 10 (Stacked Height : 1820 mm) - Armchair x 6 (Stacked Height : 1480 mm)

Bench x 2 (Stacked Height : 1080 mm).

**3-year guarantee**

## DIMENSIONS (cm)

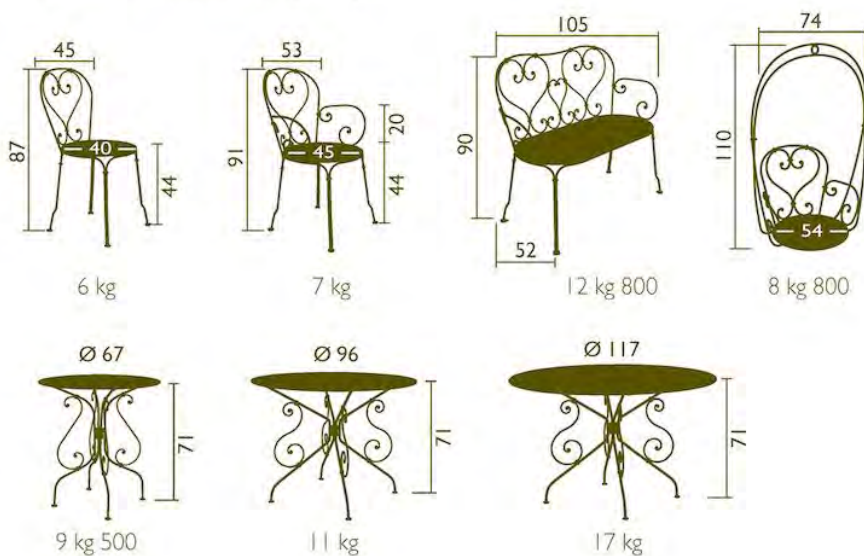

RANGE Design Pascal MOURGUE  
**ALIZE**

Registered trademark



Adjustable and stacking sunlounger - 8906



Stacking low table Ø 48 cm  
8960

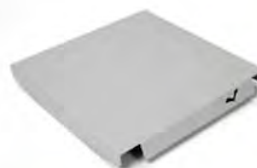

**NEW**

Removable connecting shelf - 8905  
For sunloungers only.



Adjustable deck chair  
Removable footrest - 8908



Adjustable and stacking low armchair  
8907

# RANGE Design Pascal MOURGUE

# ALIZE

Registered trademark



## TECHNICAL CHARACTERISTICS

Partitioned aluminium and sheet aluminium frame.

Tearproof simple weave Outdoor Technical Fabric covering (Polyester coated with PVC).

Very High Protection Treatment for outdoor use.

100% polyester baked anti-UV powder coating.

Sunlounger : adjustable backrest (3 positions), adjustable footrest (2 positions).

Zero gravity position available.

Alize connecting shelf : steel frame. 1-year guarantee.

Deckchair : adjustable backrest (2 positions), removable footrest with attachment system.

Can be stored beneath the armchair.

Stackable : Low armchair x 10 (Stacked Height : 1610 mm)

Sunlounger x 15 (Stacked Height : 2250 mm) - Low table x 20 (Stacked Height : 620 mm).

### 3-year guarantee

## DIMENSIONS (cm)

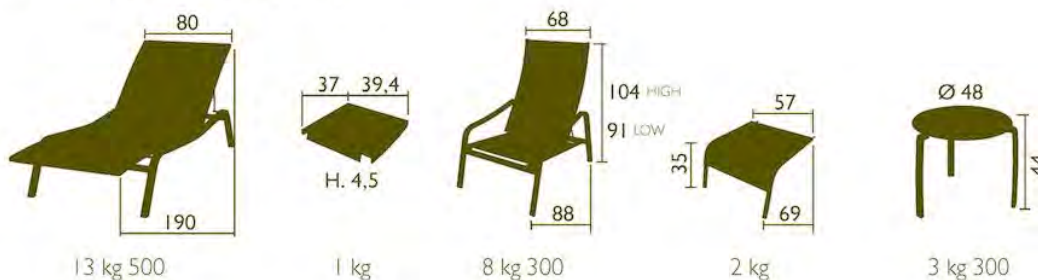



CHAIR Design JC de Castelbajac  
**ANGE**

Registered trademark



TECHNICAL CHARACTERISTICS

Steel rod base.

Steel sheet seat.

Laser cut sit and backrest.

Hand forged wings.

Very High Protection Treatment for outdoor use.

100% polyester baked anti-UV powder coating.

**3-year guarantee**



7 kg



0307

FOLDING CHAIR Design Sophie LABAYLE  
**BAGATELLE**

Registered trademark



### TECHNICAL CHARACTERISTICS

Drawn steel frame.

Sheet steel back and seat

Laser cut steel pattern on back.

High Protection Treatment for outdoor use.

100 % polyester baked anti-UV powder coating.

**1-year guarantee**

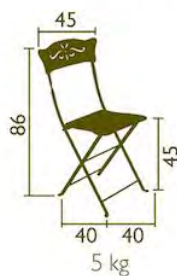



5001

FOLDING CHAIR

# Bistro Classique



## TECHNICAL CHARACTERISTICS

First quality laquered and anti-rust treated steel base.

Lacquered wooden curved slats.

Plastic part for slower and safer folding.

One piece crossbar. Foot protectors.

100% polyester baked anti-UV powder coating.

**1-year guarantee**

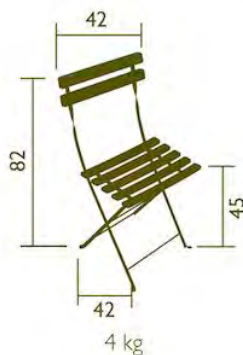

MAJ nov. 2009.





6301

FOLDING CHAIR

# Bistro Duraflon®



## TECHNICAL CHARACTERISTICS

First quality laquered and anti-rust treated steel base.

Resin High quality curved slats with Duraflon®.

Plastic part for slower and safer folding.

One piece crossbar. Foot protectors.

100% polyester baked anti-UV powder coating.

**1-year guarantee**

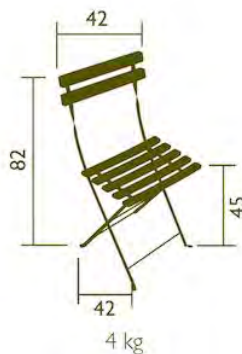





Folding chair  
0101



Adjustable chaise longue  
1601

# Bistro Metal

## TECHNICAL CHARACTERISTICS



### FOLDING CHAIR

- First quality laquered and anti-rust treated steel base.
- Galvanised steel curved slats.
- Plastic part for slower and safer folding.
- One piece crossbar. Foot protectors.
- 100% polyester baked anti-UV powder coating.

#### 1-year guarantee

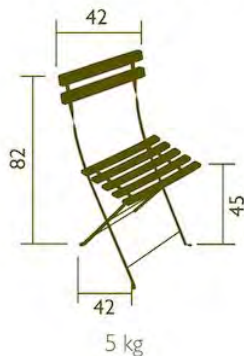

### ADJUSTABLE CHAISE LONGUE

- Steel frame.
- Curved slats.
- Adjustable backrest (3 positions).
- Plastic part for slower and safer folding.
- One piece crossbar. Foot protectors.
- Very High Protection Treatment for outdoor use.
- 100 % polyester baked anti-UV powder coating.

#### 3-year guarantee





5107

FOLDING CHAIR

# Bistro Naturel



## TECHNICAL CHARACTERISTICS

First quality laquered and anti-rust treated steel base.

Natural wooden curved slats + Textrol®.

Plastic part for slower and safer folding.

One piece crossbar. Foot protectors.

100% polyester baked anti-UV powder coating.

**1-year guarantee**

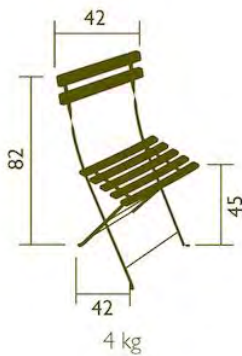



Rectangular table  
2 persons  
37 x 57 cm - 6,5 kg - 6034



Square table  
2 persons  
57 x 57 cm - 8 kg - 6042



Rectangular table - 3/4 persons  
77 x 57 cm - 8,5 kg  
with parasol hole - 0243



Rectangular table  
4 persons  
97 x 57 cm - 10 kg  
with parasol hole - 0239



Rectangular table  
6 persons  
117 x 77 cm - 15 kg  
with parasol hole - 0240



Square table  
3/4 persons  
71 x 71 cm - 10 kg  
with parasol hole - 0244

## FOLDING TABLES

# Bistro



## TECHNICAL CHARACTERISTICS

First quality laquered and anti-rust treated steel base.

Steel sheet table top with parasol hole. Foot protectors.

100% polyester baked anti-UV powder coating.

**1-year guarantee**





Round table - 6/8 persons  
Ø 117 cm - 16,5 kg  
with parasol hole - 0237



Round table - 4/5 persons  
Ø 96 cm - 12 kg  
with parasol hole - 0235



Round table - 3/4 persons  
Ø 77 cm - 9,5 kg  
with parasol hole - 0233



Round table  
2 persons  
Ø 60 cm - 6 kg - 0245

## FOLDING TABLES

# Bistro



## TECHNICAL CHARACTERISTICS

First quality laquered and anti-rust treated steel base.

Steel sheet table top with parasol hole. Foot protectors.

100% polyester baked anti-UV powder coating.

**1-year guarantee**





8 persons  
Without parasol hole - 024 l  
With parasol hole - 025 l

## FOLDING TABLE CARGO

Registered trademark



### TECHNICAL CHARACTERISTICS

Steel base.

Solid steel sheet table top.

With or without parasol hole.

Very High Protection Treatment for outdoor use.

100 % polyester baked anti-UV powder coating.

**3-year guarantee**



FOLDING RANGE

# CASTILLE PLUS

Registered trademark



Folding chair - 1901



Folding armchair - 1902



Side table  
Ø 90 cm - 1960



Table 160 x 90 cm  
6 persons - 1930



Fermob  
outdoor lounge

# FOLDING RANGE

# CASTILLE PLUS

Registered trademark



## TECHNICAL CHARACTERISTICS

Seats: frame and back in flat steel and steel rod. Perforated sheet steel seat.

Locking system.

Tables: base in solid steel, 20 x 20 mm square. Flat steel girdle. Perforated sheet steel top.

Very High Protection Treatment for outdoor use.

100% polyester baked anti-UV powder coating.

**3-year guarantee**

## DIMENSIONS (cm)

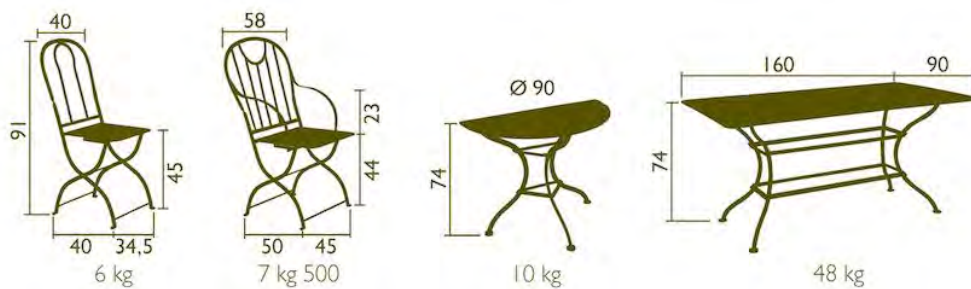



Bench 5/6 persons  
1025 - Black frame  
1035 - Savanna frame  
1045 - Anodic grey frame

BENCH Design Juliette LIBERMAN  
**CHARIVARI**

Registered trademark



### TECHNICAL CHARACTERISTICS

Steel bench base.

Seat : curved aluminium slats.

Very High Protection Treatment for outdoor use.

100% polyester baked anti-UV powder coating.

Delivered assembled.

**3-year guarantee**

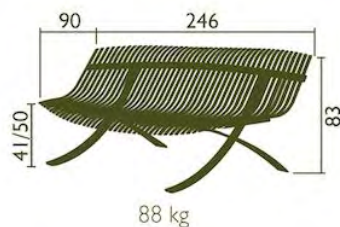



RANGE Design JC de Castelbajac  
**COCARDE**

Registered trademark



Folding chair  
Red/White/Green combination 010937  
Blue/White/Red combination 010922  
Green/White/Yellow combination 010923



Folding table Ø 60 cm  
Red/White/Green combination 600937  
Blue/White/Red combination 600922  
Green/White/Yellow combination 600923



RANGE Design JC de Castelbajac

# COCARDE

Registered trademark



## TECHNICAL CHARACTERISTICS

Laquered steel base.

Galvanised steel curved slats.

Printed steel sheet table top.

High Protection Treatment for outdoor use.

100% polyester baked anti-UV powder coating.

**1-year guarantee**

## DIMENSIONS (cm)

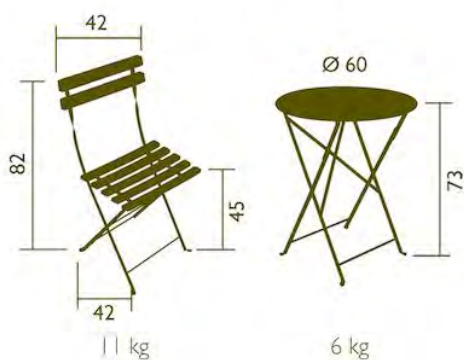



## FOLDING CHAIR CŒUR

Registered trademark



### TECHNICAL CHARACTERISTICS

Steel frame.

Steel seat and backrest with laser-cut.

Very High Protection Treatment for outdoor use.

100% polyester baked anti-UV powder coating.

**3-year guarantee**





COLLAPSIBLE TABLE  
**COSMO**

Registered trademark

1980  
8 persons



### TECHNICAL CHARACTERISTICS

Round tubular steel base.

Electro-zinc coated solid steel sheet table top.

Very High Protection Treatment for outdoor use.

100% polyester baked anti-UV powder coating.

**3-year guarantee**



RANGE  
**COSTA**

Registered trademark



Stacking chair - 7901



Stacking armchair - 7902



Low stacking armchair - 7904



High chair - 7903



RANGE  
**COSTA**

Registered trademark



Collapsible table  
80 x 80 cm  
4 persons - 8143



Collapsible high table  
80 x 80 cm  
4 persons - 7950

**NEW**



Low table  
80 x 100 cm - 7960

**NEW**



Table with extension  
160/240 x 80 cm  
8/10 persons - 8146



# RANGE COSTA

Registered trademark



## TECHNICAL CHARACTERISTICS

Aluminium frame.

Tables : aluminium table top.

Seat and backrest in tearproof Outdoor Technical Fabric (Polyester coated with PVC), simple or double weave.

Very High Protection Treatment for outdoor use.

100% polyester baked anti-UV powder coating.

Stackable : Chair x 10 (Stacked Height : 1210 mm) - Armchair x 7 (Stacked Height : 1140 mm).

Low armchair x 5 (Stacked Height : 920 mm).

**3-year guarantee**

## DIMENSIONS (cm)

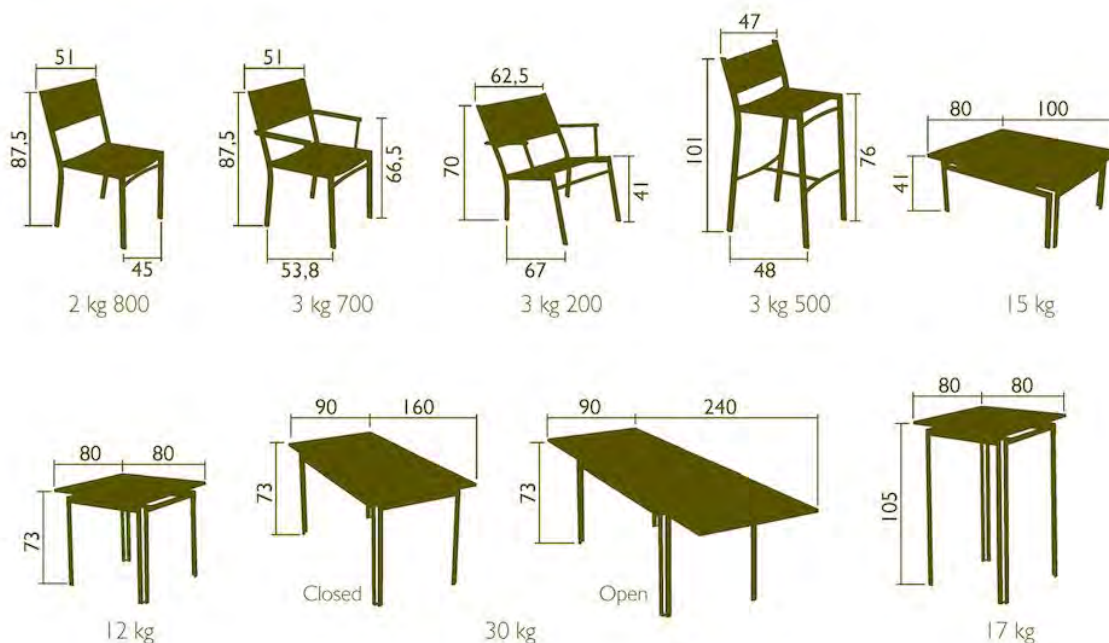



COLLAPSIBLE TABLE  
**CRAFT**

Registered trademark

1970  
8 persons



TECHNICAL CHARACTERISTICS

Square tubular steel base

Electro-zinc coated solid steel sheet table top

Very High Protection Treatment for outdoor use

100% polyester baked anti-UV powder coating

**3-year guarantee**



42 kg



# CUSHIONS

CUSHIONS FOR THE I 900, MONTMARTRE,  
AND LOUVRE CHAIRS

Foam thickness : 3 cm

4 ties

Covers removable and washable at 30°

Teflon stainproof treatment

Packed by 1

## Chairs - Ø 40 cm



Natural : 277300



Beige : 277301



Striped : 277302

## Armchairs - Ø 44 cm



Natural : 277400



Beige : 277401



Striped : 277402

# CUSHIONS

## CUSHIONS FOR THE BISTRO, CŒUR AND METISSE CHAIRS

2 button-like oversewn seam  
Foam thickness : 3 cm  
Round edges  
4 ties  
Not removable covers, washable at 30°  
Teflon stainproof treatment  
Packed by 2

### Chairs - 38 x 30 cm



Beige : 277201



Striped : 277202

## CUSHIONS FOR THE CASTILLE PLUS RANGE

Polyester  
4 ties  
Not removable covers, washable at 30°  
Teflon stainproof treatment  
Packed by 2

### Chairs - 36,5 x 36,5 cm



Natural : 277500

### Armchairs - 48 x 44 cm



Natural : 277501

FOLDING RANGE Design Pascal MOURGUE

# DUNE

Registered trademark



Folding chair  
Simple weave – 1301  
Double weave – 1326



Folding armchair  
Simple weave - 1402  
Double weave - 1427



Folding low armchair  
Simple weave – 1304  
Double weave – 1314



Folding ottoman  
Simple weave – 1305  
Double weave – 1315



Folding adjustable sunlounger 190 x 65 cm  
With 20 cm Ø wheels  
Simple weave – 1308  
Double weave – 1318



# FOLDING RANGE Design Pascal MOURGUE

# DUNE

Registered trademark



## TECHNICAL CHARACTERISTICS

Drawn steel frame.

Very High Protection Treatment for outdoor use.

100% polyester baked anti-UV powder coating.

Seat and back in tear-proof Outdoor Technical Fabric (polyester coated with PVC), simple or double weave.

The back of the folding low armchair is self-adjusting.

The back of the Dune sunlounger is adjustable (4 positions).

**3-year guarantee**

## DIMENSIONS (cm)



4 kg 600



6 kg

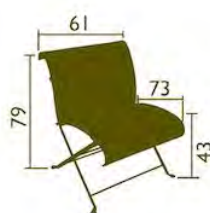

7 kg 500



6 kg

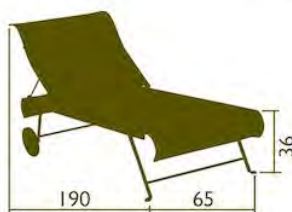

24 kg

FOLDING RANGE Design Pascal MOURGUE  
**DUNE TOILES DU SOLEIL®**

Registered trademark



Folding chair



Folding armchair



Folding low armchair



Folding adjustable  
 sunlounger 190 x 65  
 With 20 cm Ø wheels



Folding ottoman

	COLLIOURE		St-CYPRIEN	Ste-COLOMBE
	Frame colours		Frame colour	Frame colour
	Savanna	Poppy	Russet	Storm grey
Folding chair	131112	131167	131209	131326
Folding armchair	141912	141967	142009	142426
Folding low armchair	132512	132567	132809	132926
Folding ottoman	136512	136567	136809	136926
Adjustable sunlounger	132112	132167	132209	132326



# FOLDING RANGE Design Pascal MOURGUE

# DUNE TOILES DU SOLEIL®

Registered trademark



## TECHNICAL CHARACTERISTICS

Drawn steel frame.

Very High Protection Treatment for outdoor use.

100% polyester baked anti-UV powder coating.

Seat and back in tear-proof Outdoor Technical Fabric (polyester coated with PVC), simple or double weave.

The back of the folding low armchair is self-adjusting.

The back of the Dune sunlounger is adjustable (4 positions).

**3-year guarantee**

## DIMENSIONS (cm)

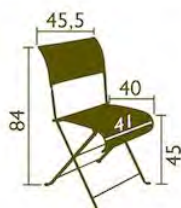

4 kg 600



6 kg



7 kg 500



6 kg



24 kg



## COLLAPSIBLE SMALL TABLE ELISE

Registered trademark

Small table 2/3 persons  
Ø 67 cm - 7030



### TECHNICAL CHARACTERISTICS

Flat steel base and scrolls.

Steel sheet table top.

High Protection Treatment for outdoor use.

100% polyester baked anti-UV powder coating.

**1-year guarantee**



RANGE Design Patrick JOUIN

# FACTO

Registered trademark



High stool - 2503



Stacking chair - 2501





RANGE Design Patrick JOUIN  
**FACTO**

Registered trademark



## TECHNICAL CHARACTERISTICS

Tubular steel frame.

Steel sheet seat and backrest.

Very High Protection Treatment for outdoor use.

100 % polyester baked anti-UV powder coating.

Protective pad for stacking and 150 x 150 mm septum soundproofed and anti-vibration sheet.

Stackable : Chair x 10 (Stacked Height : 1100 mm).

**3-year guarantee**

## DIMENSIONS (cm)

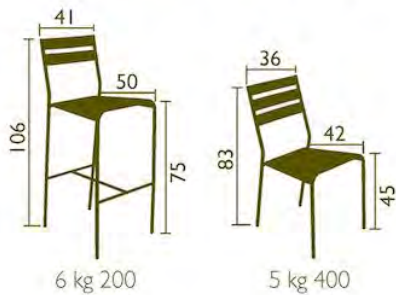

FOLDING TABLE  
**FLOREAL**

Registered trademark



Folding table Ø 60 cm  
2 persons - 0230



Folding table Ø 77 cm  
3/4 persons  
With parasol hole - 0234



Folding table Ø 96 cm  
4/5 persons  
With parasol hole - 0236



**Fermob**  
outdoor lounge

# FOLDING TABLE FLOREAL

Registered trademark



## TECHNICAL CHARACTERISTICS

Drawn steel base.

Perforated steel sheet table top.

High Protection Treatment for outdoor use.

100 % polyester baked anti-UV powder coating.

**1-year guarantee**

## DIMENSIONS (cm)

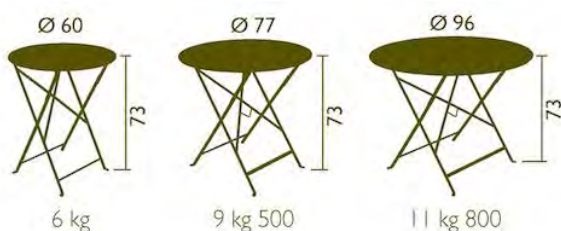

RANGE Design Harald Guggenbichler

# FLOWER

Registered trademark



Armchair - 7100



Armchair (without perforation)  
7101



Pedestal table Ø 67 cm  
2 persons - 7110



RANGE Design Harald Guggenbichler

# FLOWER

Registered trademark



## TECHNICAL CHARACTERISTICS

Tubular steel frame.

Electro-zinc coated steel sheet seat (with or without flower pattern).

Steel sheet table top.

Very High Protection Treatment for outdoor use.

100% polyester baked anti-UV powder coating.

**3-year guarantee**

## DIMENSIONS (cm)



RANGE Design Andrée Putman

# INSIDE OUT

NEW

Registered trademark



Stacking chair - 1501



Stacking low armchair - 1504



Collapsible table - 1510



Collapsible low table - 1520



Sunlounger - 1506

Launch in 2011

RANGE Design Andrée Putman

# INSIDE OUT

Registered trademark



## TECHNICAL CHARACTERISTICS

Seats : aluminium frame and polyester weaved thread.

Table : steel base and aluminium table top.

Very High Protection Treatment for outdoor use.

100% polyester baked anti-UV powder coating.

Stackable : Chair x 4 (Stacked Height : 970 mm) - Low armchair x 4 (Stacked Height : 890 mm).

**3-year guarantee**

## DIMENSIONS (cm)

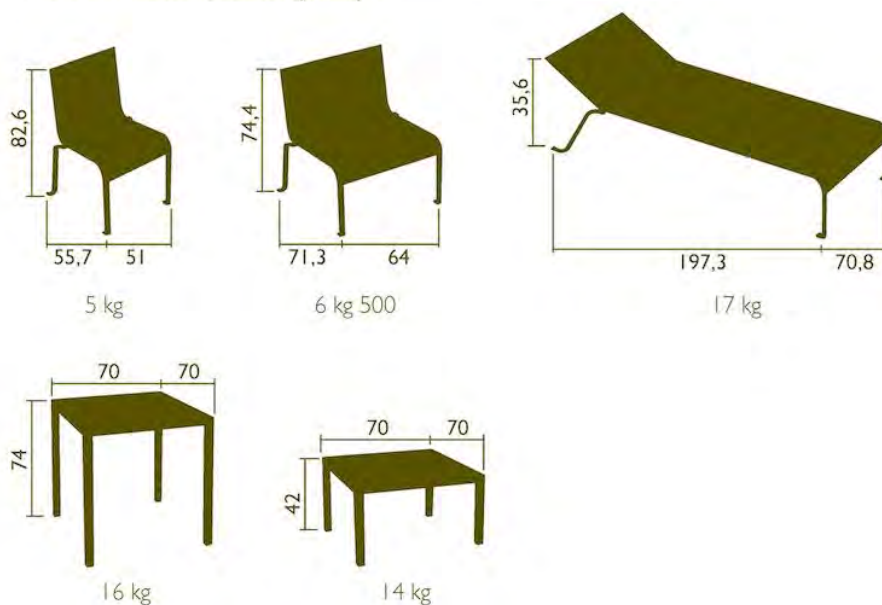



150 cm - 1000  
200 cm - 1001

## STEEL BENCH LOUISIANE

Registered trademark



### TECHNICAL CHARACTERISTICS

T flat steel base.

Seat: 20 galvanized steel slats.

Very High Protection Treatment for outdoor use.

100 % polyester baked anti-UV powder coating.

Delivered unassembled.

**3-year guarantee**

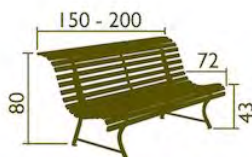

150 cm - 33 kg 300  
200 cm - 34 kg 800





0801



0802

## STACKING CHAIR AND ARMCHAIR LOUVRE

Registered trademark



### TECHNICAL CHARACTERISTICS

Steel rod base.

Flat steel backrest.

Perforated steel sheet seat.

High Protection Treatment for outdoor use.

100 % polyester baked anti-UV powder coating.

Stackable : Chair x 10 (Stacked Height : 1570 mm) - Armchair x 7 (Stacked Height : 1400 mm).

**1-year guarantee**

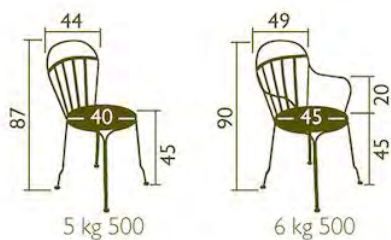

RANGE Design Frédéric SOFIA

# LUXEMBOURG

Registered trademark



Stacking chair - 4101



Stacking armchair - 4102



Folding table 80 x 140 cm  
with parasol hole - 6 persons - 4130



Side table / Bar with wheels  
Movable top - 4164



Collapsible table 80 x 80 cm  
with parasol hole - 4 persons - 4131



Fermob  
outdoor lounge

RANGE Design Frédéric SOFIA

# LUXEMBOURG

Registered trademark



Stacking low armchair - 4104



Headrest - 4165



Large low table / Garden bench - 4161



Small low table / Footrest - 4160

RANGE Design Frédéric SOFIA

# LUXEMBOURG

Registered trademark



Low armchair Duo - 4105



Stacking bench 2/3 places  
4115



Bench 3/4 places  
4110

**NEW**

RANGE Design Frédéric SOFIA

# LUXEMBOURG

Registered trademark



## TECHNICAL CHARACTERISTICS

Aluminium tubular frame.

Shaped extruded aluminium slats for backrest, seat and armrests.

Very High Protection Treatment for outdoor use.

100% polyester baked anti-UV powder coating.

Stackable : Chair x 10 (Stacked Height : 1210 mm) - Armchair x 8 (Stacked Height : 960 mm)

Low armchair x 6 (Stacked Height : 840 mm) - Bench 2/3 .1 x 4 (Stacked Height : 1000 mm).

**3-year guarantee**

## DIMENSIONS (cm)

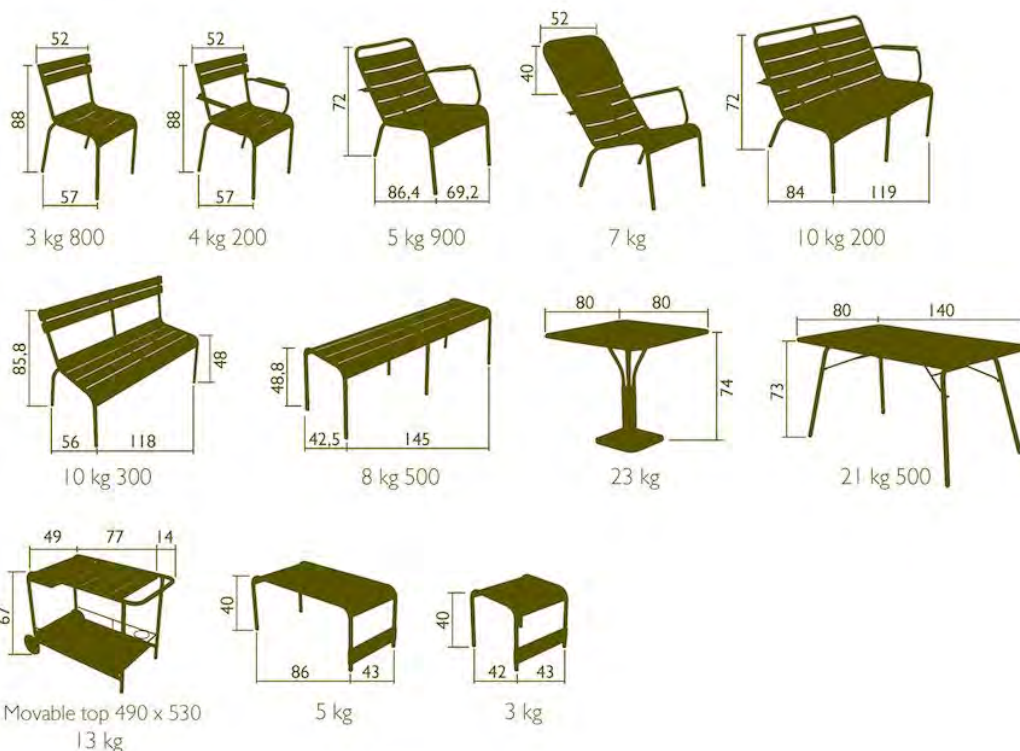

NEW



Stacking armchair  
4106



Collapsible table  
4107

RANGE

# LUXEMBOURG KID

Registered trademark

## TECHNICAL CHARACTERISTICS



### CHAIR

Aluminium tubular frame.

Shaped extruded aluminium slats for backrest and seat.

For children from 3 to 6.

Very High Protection Treatment for outdoor use.

100% polyester baked anti-UV powder coating.

Stackable : Chair x 3 (Stacked Height : 690 mm).

**3-year guarantee**



1 kg 100



### TABLE

Lacquered steel frame.

For children from 3 to 6.

High Protection Treatment for outdoor use.

100% polyester baked anti-UV powder coating.

**1-year guarantee**



8 kg 500

Fermob  
outdoor lounge



1939  
6/8 persons

COLLAPSIBLE TABLE  
**MANOSQUE**

Registered trademark



TECHNICAL CHARACTERISTICS

Tubular steel base. Flat steel belt.

Solid sheet steel table top.

High Protection Treatment for outdoor use.

100% polyester baked anti-UV powder coating.

**1-year guarantee**

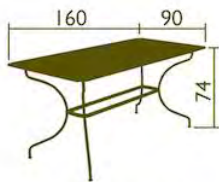

21 kg 800

**Fermob**  
outdoor lounge



0107

# FOLDING CHAIR METISSE

Registered trademark



## TECHNICAL CHARACTERISTICS

- Drawn steel base.
- Laser-cut steel sheet seat and backrest, woven effect.
- High Protection Treatment for outdoor use.
- 100 % polyester baked anti-UV powder coating.

**1-year guarantee**



4 kg 900





RANGE  
**MONTMARTRE**

Registered trademark



Stacking chair - 4601



Stacking armchair - 4602



Portable bar - 1060



Table Ø 96 cm - 4/5 persons  
with parasol hole - 0630



Table Ø 117 cm - 6/8 persons  
with parasol hole - 0631

# RANGE MONTMARTRE

Registered trademark



## TECHNICAL CHARACTERISTICS

Steel rod frame.

Perforated steel sheet seat.

Perforated steel sheet table top with parasol hole.

High Protection Treatment for outdoor use.

100 % polyester baked anti-UV powder coating.

Stackable : Chair x 10 (Stacked Height : 1600 mm) - Armchair x 7 (Stacked Height : 1350 mm).

**1-year guarantee**

## DIMENSIONS (cm)

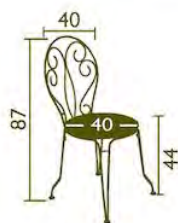

6 kg 400

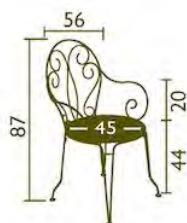

7 kg 300



10 kg 500



14 kg 200



4 kg 500

COLLAPSIBLE RANGE  
**OPERA**

Registered trademark



Table Ø 67 cm  
2 persons - 0930



Table Ø 96 cm  
4/5 persons  
With parasol hole - 0932



Table Ø 117 cm  
6/8 persons  
With parasol hole - 0934



Table 77 x 77 cm  
2/3 personnes - 0939



Table 117 x 77 cm  
6 persons  
With parasol hole - 0941

# COLLAPSIBLE RANGE OPERA

Registered trademark



## TECHNICAL CHARACTERISTICS

Tubular steel base.

Flat steel belt.

Solid steel sheet table top.

High Protection Treatment for outdoor use.

100% polyester baked anti-UV powder coating.

**1-year guarantee**

## DIMENSIONS (cm)

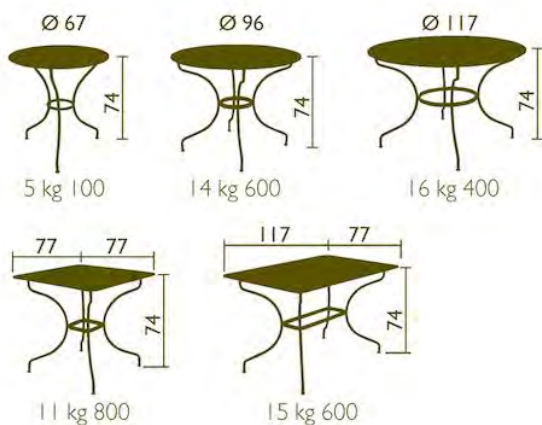



STEEL BENCH Design Harald GUGGENBICHLER

# ORIGAMI

Registered trademark



## TECHNICAL CHARACTERISTICS

Bench made from laser-cut steel sheet.

4 polypropylene foot protectors.

High Protection Treatment for outdoor use.

100% polyester baked anti-UV powder coating.

**1-year guarantee**



# PARASOL BASE

Registered trademark



## TECHNICAL CHARACTERISTICS

Pedestal base cast iron clover-leaf. Solid steel rod.

The adjustable hole diameter, max. 40 mm, means numerous parasol formats can be accommodated.

Five predefined tilt angles.

High Protection Treatment for outdoor use.

100% polyester baked anti-UV powder coating.

**1-year guarantee**

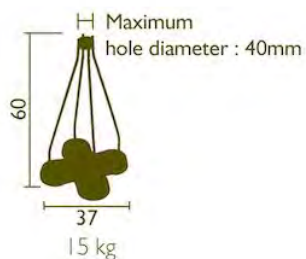

1064

FOLDING RANGE Design Pascal MOURGUE

# PLEIN AIR

Registered trademark



Folding chair - 8301



Folding armchair - 8303



Folding table 71 x 71 cm  
2 persons - 8333



Folding table Ø 120 cm  
6/8 persons - 8330

**New folding  
system**



**fermob**  
outdoor lounge

# FOLDING RANGE Design Pascal MOURGUE

# PLEIN AIR

Registered trademark



## TECHNICAL CHARACTERISTICS

Oval tubular steel frame.

Steel sheet table top.

Armchair : armrests in cast aluminium.

Very High Protection Treatment for outdoor use.

100% polyester baked anti-UV powder coating.

Seat and backrest in tearproof Outdoor Technical Fabric (Polyester coated with PVC), simple or double weave.

**3-year guarantee**

## DIMENSIONS (cm)

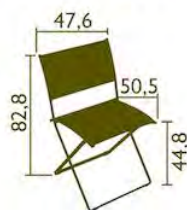

4 kg 300



4 kg 500



21 kg

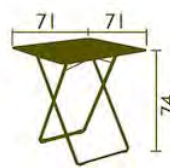

10 kg



RANGE Design Pascal MOURGUE

# RENDEZ-VOUS

Registered trademark



Stacking large armchair - 9502



Stacking armchair - 9503



Table Ø 110 cm - 6/8 persons  
9530



Table 160 x 90 cm - 6/8 persons  
9532



Low table Ø 70 cm - 9565



Nest of tables - 9510



Fermob  
outdoor lounge

RANGE Design Pascal MOURGUE

# RENDEZ-VOUS

Registered trademark



## TECHNICAL CHARACTERISTICS

Tubular steel frame.

Seats : perforated steel sheet backrest and seat, rice grain pattern.

Table : legs in steel rod, steel sheet table top.

Very High Protection Treatment for outdoor use.

100% polyester baked anti-UV powder coating.

Stackable : Large armchair x 10 (Stacked Height : 1 200 mm)

Armchair x 10 (Stacked Height : 1 050 mm)

**3-year guarantee**

## DIMENSIONS (cm)

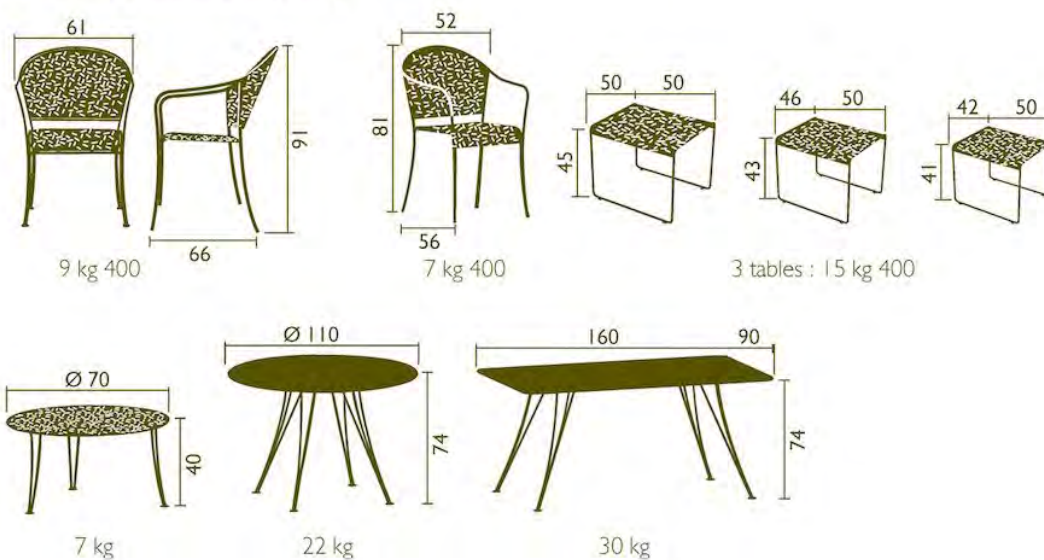

RANGE  
**ROMANE**

Registered trademark



Ø 120 cm round table without parasol hole - 2130  
Ø 120 cm round table with parasol hole - 2140  
6 persons



Ø 140 cm round table without parasol hole - 2131  
Ø 140 cm round table with parasol hole - 2141  
6/8 persons



Table 180 x 100 cm - 2134  
8/12 persons



Table with extension - 2138  
Closed 200 x 100 cm or Open 300 x 100 cm  
10/14 persons

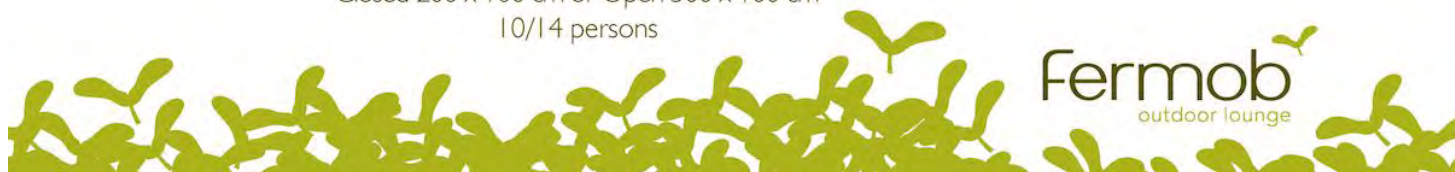

# RANGE ROMANE

Registered trademark



## TECHNICAL CHARACTERISTICS

25 x 25 mm solid steel base.

Flat steel belt.

Steel sheet table top.

Adjustable foot for table with extension.

Very High Protection Treatment for outdoor use.

100 % polyester baked anti-UV powder coating.

**3-year guarantee**

## DIMENSIONS (cm)

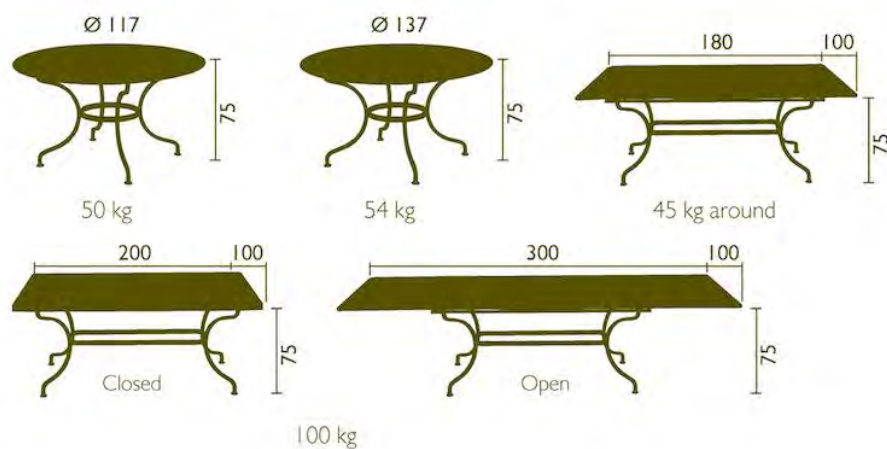



Small wheeled table  
double top - 1062



Small table  
double top perforated - 1061

# SMALL TABLES

Registered trademark



## TECHNICAL CHARACTERISTICS

Legs in steel rod.

Circles of steel rod.

Top in sheet steel, perforated or plain.

High Protection Treatment for outdoor use.

100% polyester baked anti-UV powder coating.

**1-year guarantee**

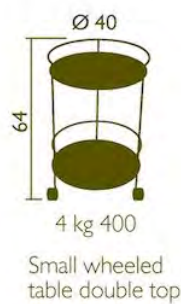



ARMCHAIR Design Harald GUGGENBICHLER

# SURPRISING LOUNGER

Registered trademark



## TECHNICAL CHARACTERISTICS

Laser-cut steel rod and sheet frame.

Very High Protection Treatment for outdoor use.

100 % polyester baked anti-UV powder coating.

The footrest can be stored beneath the armchair.

**3-year guarantee**

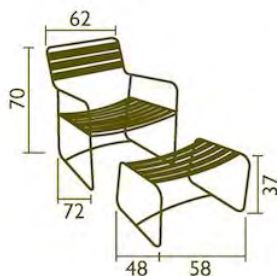

15 kg 500

Fermob  
outdoor lounge

TABLE Design Delo LINDO  
TABLABRI

Registered trademark



Rectangular table 160 x 90  
6 persons  
Ref : 1990

# TABLE Design Delo LINDO TABLABRI

Registered trademark



## TECHNICAL CHARACTERISTICS

### TABLE

Round tubular steel base.

Steel sheet table top.

Storage of the 4 masts under the table top.

Very High Protection Treatment for outdoor use.

100% polyester baked anti-UV powder coating.

### CANVAS

Removable 100% recyclable string canvas.

- anti-UV (stops 97% of UV)
- water resistant
- hypoallergenic class I / treated against mould
- washable 40° / no dry cleaning
- frame wind-resistant up to 30km/h. Stronger wind may loosen the canvas, but will not tip the table over.

### 3-year guarantee

## DIMENSIONS (cm)

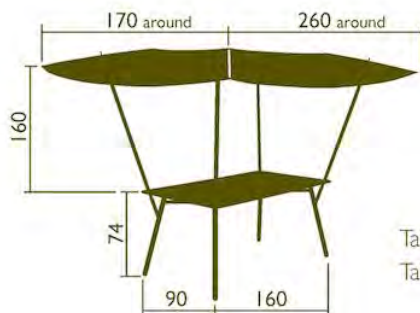

Table : 42 Kg

Table + 4 masts + canvas: 48 kg





## FOLDING TABLE TERTIO

Registered trademark



6030  
2 persons

### TECHNICAL CHARACTERISTICS

Tubular steel frame.

Solid steel sheet table top.

Extremely simple to fold away. Table stands up perfectly when folded.

High Protection Treatment for outdoor use.

100% polyester anti-UV powder coating, oven baked.

**1-year guarantee**



Fermob  
outdoor lounge



COLLAPSIBLE LOW TABLE

# TOM POUCE

Registered trademark



## TECHNICAL CHARACTERISTICS

Drawn steel pedestal base.

Non-perforated steel sheet table top.

High Protection Treatment for outdoor use.

100 % polyester baked anti-UV powder coating.

**3-year guarantee**



MULTIFUNCTIONAL RANGE Design Lucile SOUFFLET  
**UP&DOWN**

Registered trademark

Multifunctional table | 110 x 90 cm  
4 persons  
Frame black 9131  
Frame savanna 9132



Multifunctional chair  
Frame black 9108  
Frame savane 9112

*High position*



*Low position*

# MULTIFUNCTIONAL RANGE Design Lucile SOUFFLET

# UP&DOWN

Registered trademark



## TECHNICAL CHARACTERISTICS

Steel rod frame.

Seat made from laser-cut HLE steel sheet.

Steel sheet table top.

Exclusive upper and lower position-lock system.

High Protection Treatment for outdoor use.

100% polyester baked anti-UV powder coating.

**1-year guarantee**

## DIMENSIONS (cm)

